

Measuring State Parameters of the Atmosphere

Some Applications of Atmospheric Thermodynamics

Al Cooper

Earth Observing Laboratory, NCAR

IDEAS-4 Tutorial

Introduction

Goals of This Presentation

Present two complementary aspects related to atmospheric thermodynamics:

- 1 Discuss some basics regarding how measurements of thermodynamic state variables are measured by a research aircraft
- 2 Show some useful applications of atmospheric thermodynamics to how those measurements are made



STATE VARIABLES

What Are State Variables?

- Those variables needed to specify the thermodynamic state of the system, in this case the atmosphere.
- If we consider a moist atmosphere, in general we need three variables to specify the state. They may be taken, for example, to be *temperature*, *pressure*, and *water vapor pressure*.

Other variables can then be determined from these, for example:

- **density** from the perfect gas law
- **relative humidity** from knowledge of the equilibrium vapor pressure vs T for water
- **dew point** also from knowledge of the equilibrium vapor pressure vs T for water



TEMPERATURE SENSORS

Types of Temperature Sensors

- 1 Resistive-element sensors:
 - often, platinum wire
 - resistance varies with temperature
- 2 radiometric:
 - CO₂ absorbs and re-emits radiation in short distances at some specific wavelengths
 - The intensity of such radiation varies with the temperature
- 3 Others sensors are also sometimes used, including thermocouple junctions and thermistors



THE STANDARD SENSOR

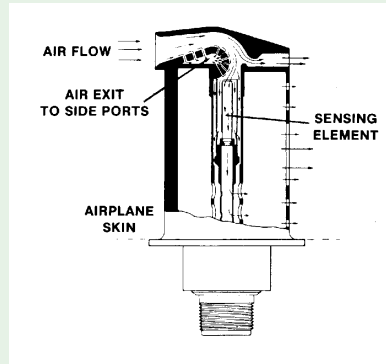

EFFECT OF AIRSPEED ON IN SITU SENSORS

Airflow Approaching a Stagnation Point

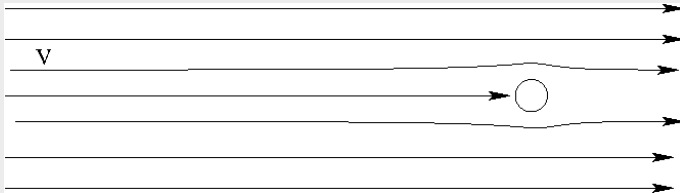

- At boundaries, airspeed tends to zero relative to the boundary.
- The result is compressional adiabatic heating of the air
- The sensing wire therefore is in contact with warmed air, not ambient air



WHAT IS TTX?

Definition

TTX is the measured temperature determined from the resistance of the wire.

- It is named “total” temperature because it is approximately the total temperature of air brought to a stagnation point.
- It is actually closer to the “recovery” temperature, defined below



HOW IS TTX RELATED TO ATX?

Conservation of Energy

First Law: $dU = \delta Q - \delta W$, and for a perfect gas $dU = c_v dT$

On a streamline starting with varying speed V ,

$$\delta Q = 0 \text{ and } -\delta W = p\delta V$$

To U , must add kinetic energy $\frac{1}{2}\rho V_a^2$, with air density ρ_a :

$$\frac{1}{2}V^2 + c_v T + \frac{p}{\rho_a} = \text{Constant}$$

Because $\frac{p}{\rho_a} = R_d T$ and $c_v + R_d = c_p$,

$$\frac{1}{2}V^2 + c_p T = \text{Constant}$$



MAGNITUDE OF THE HEATING

Heating is about 5°C at 100 m/s, increasing to about 30°C at airspeeds reached by the GV.

Accurate correction for this airspeed thus is quite important, especially at high airspeed.

► Skip Details: The Recovery Factor

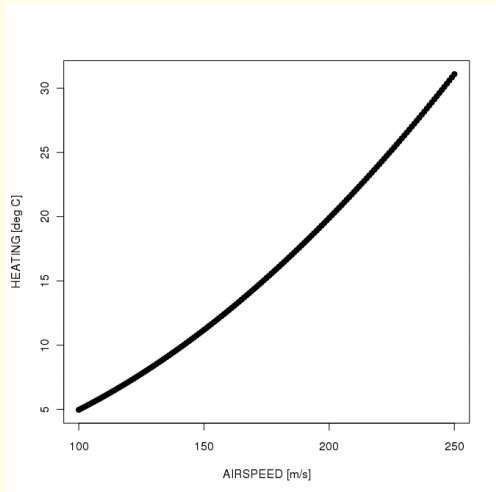

THE RECOVERY FACTOR

A Further Correction That Depends On Probe Geometry

- The air does not reach complete stagnation at a distance in thermal contact with the sensing wire. One might expect that the temperature that affects the wire is that present at a distance from the sensor of about a mean free path for air molecules.
- This is usually dealt with via a “recovery factor” that varies with sensor but may be as high as 0.98 (where 1.0 would apply for a stagnation point).
- Often this is determined from flight maneuvers where the aircraft varies airspeed while flying through a region of uniform temperature so the effect of airspeed on the measurement can be detected.



WHAT HAPPENS IN CLOUD?

If the sensor becomes wet, the measurement will be wrong

- Consider: $RH \approx 100\%$, wet sensor
- Air is heated on approach to sensor, so RH decreases
- The water on the sensor and in drops partially evaporates, cooling the sensor
- At the extreme, the sensor approaches the wet-bulb temperature, cooling by a few degrees Celsius

▶ [Skip Details on the wet-bulb temperature](#)



THE WET-BULB TEMPERATURE

Basic Formula

$$rL_V + c_p T = \text{Constant}$$

r is the water-vapor mixing ratio, L_V the latent heat of vaporization, c_p the specific heat at constant pressure, and T the temperature.

- As the air evaporates from the sensing wire and cloud drops, T decreases and r increases.
- At saturation, $r = r_s(T_{WB})$. The wet-bulb temperature is the temperature for which this condition is satisfied.
- Conceptually, one could plot the quantity $r_s(T')L_V + c_p T'$ vs T' and find the point at which that curve intersects the value specified by the formula above for ambient conditions $\{r, T\}$. In practice, the equation is usually solved iteratively.



HUMIDITY SENSORS

Basic Sensor Types:

- **Dew point hygrometers:** Devices that detect the presence of condensate on a chilled mirror
- **Light-absorption hygrometers:** Devices that measure the absorption of radiation at a wavelength where there is strong water absorption
- **Wet-bulb thermometers:** Devices that measure the cooling of a wetted sensor
- **Capacitance measurements or hygistor (resistance) devices:** Common in radiosondes, seldom used in research aircraft



A CHILLED-MIRROR HYGROMETER

The sensor housing

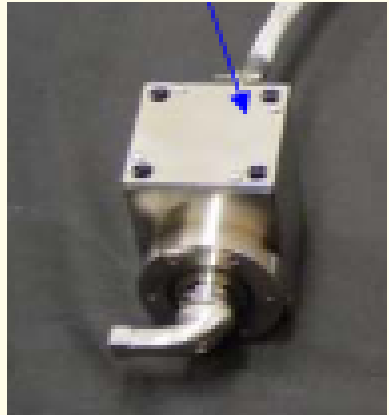

A CHILLED-MIRROR HYGROMETER

Photograph as mounted on the
GV



A CHILLED-MIRROR HYGROMETER

The control process

- Reflected light from the mirror is measured
- If the reflected light decreases, the mirror is heated, and v.v.
- The control loop is adjusted to keep just threshold condensation on the mirror

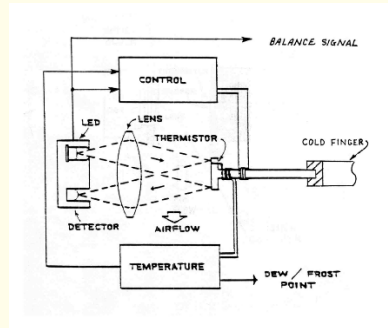

USING CHILLED-MIRROR MEASUREMENTS

Finding the Water Vapor Pressure

Definition

The dew point is the temperature at which the water vapor pressure would be in equilibrium with a plane water surface.

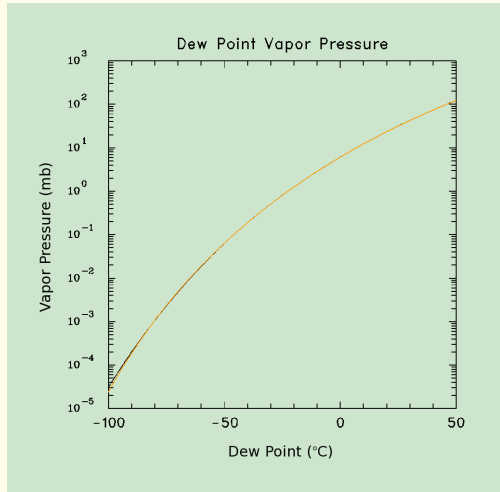

USING CHILLED-MIRROR MEASUREMENTS

Finding the Water Vapor Pressure

The functional dependence is usually expressed as $e = e_s(T_{DP})$ where e_s is the equilibrium vapor pressure function, e is the vapor pressure, and T_{DP} is the dew point.

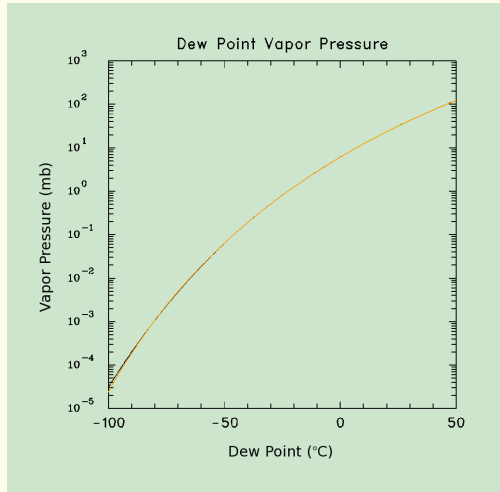

USING CHILLED-MIRROR MEASUREMENTS

Finding the Water Vapor Pressure

Formulas exist to express the function e_s , including the Clausius-Clapeyron equation, the Goff-Gratch formula, or the Murphy-Koop formula. We now use the latter.

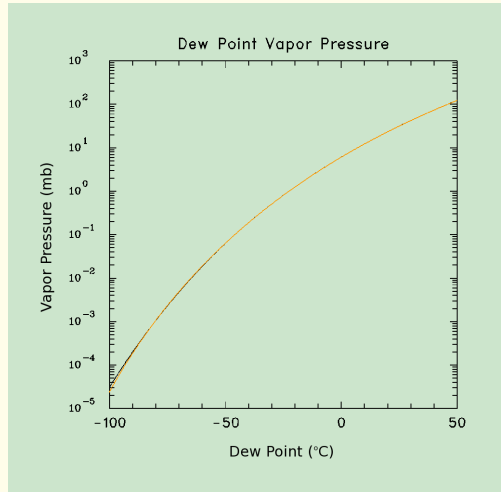

FURTHER CONSIDERATIONS

Three additional considerations when using these formulas:

- 1 The condensate on the mirror may be frost, not dew.
- 2 The pressure in the sensing chamber may differ from the ambient.
- 3 In the presence of dry air, the equilibrium vapor pressure over a plane surface is slightly higher than the equilibrium value in the absence of air.

All these require corrections. The first two are often substantial.



HUMIDITY SENSORS THAT MEASURE ABSORPTION

Beer's Law

$$\frac{dl}{l} = -\sigma n dl$$

[l is the intensity of radiation, ℓ distance, σ the molecular cross-section for absorption, and n the number density of molecules.]

$$I = I_0 e^{-\sigma \ell n}$$

- The quantity measured by instruments using absorption is then n or $\rho_w = m_w n$, the mass density of water vapor.
- Two types of radiometric hygrometer are in common use:
 - 1 Lyman-alpha hygrometers based on absorption of the Lyman-alpha line of hydrogen, which lies in the UV
 - 2 Tunable diode laser (TDL) hygrometers that work in the near IR



THE HUMIDITY VARIABLES

- Original Measurements: **DPB**, **DPT** (mirror temperatures)
- Corrected for frost-dew difference, etc: **DPBC**, **DPTC**, **DPXC**
- Derived:
 - EDPC** water vapor pressure
 - MR** water vapor mixing ratio
 - RHUM** relative humidity
 - RHODT** water vapor density
- Experimental: **MIRRORT_CR2** (cryogenic hygrometer) and some measurements from a TDL hygrometer. These are not yet processed to final engineering-unit form.



CALCULATING THE DERIVED VARIABLES

Preferred dew-point sensor

One of the dew point measurements is designated as the preferred measurement; e.g., DPXC=DPTC. Derived measurements are determined from this basic measurement.

- EDPC: determined from $e=e_s(T_{DP})$ after corrections as discussed earlier
- RHUM: $e/e_s(T)$ where T is the ambient temperature
- MR: $r = \frac{\varepsilon e}{p-e}$ where $\varepsilon = M_W/M_a$ is the ratio of the molecular weight of water to that of air and p is the total pressure
- RHODT: $\rho_w = \frac{e}{R_w T}$ where R_w is the gas constant for water vapor. This equation is also used to obtain e from measurements of ρ_w or n , such as provided by the radiometric hygrometers.



PRESSURE MEASUREMENT

The Sensors

- Many different transducers are available to measure absolute or differential pressure.
- Among the most accurate are digital quartz crystal sensors that change oscillation frequency with pressure.
- Others are capacitative, piezoelectric, piezoresistive, ...
- On aircraft, these attach to static ports designed to provide pressure close to the flight-level pressure



HOW DO STATIC PORTS WORK?

The Key Problem

Airflow around the surfaces of the aircraft creates a varying pressure field that makes accurate measurement difficult.

- Example from earlier discussion of temperature measurement:

$$\Delta p = \rho_a \frac{V^2}{2}$$

Δp can be 70 hPa under the following conditions: $p = 200$ hPa, $T = -40^\circ\text{C}$, $V = 220$ m/s.

- Pressure ports: “static buttons” located at special locations where this effect is minimized. (Corrections are still necessary.)
- Calibration: “trailing cone” and flight maneuvers to test the effects of angle of attack and sideslip



MAPPING PRESSURE FIELDS

Heights on a constant-pressure surface show pressure gradients

- GPS measurements give the height of the aircraft to few-cm accuracy. (Synoptic maps of pressure fields often use contour increments of 50 m or more.)
- It is possible to map mesoscale pressure fields by flying on constant-pressure surfaces.
- Accuracy considerations: If uncertainty in p is 0.5 mb, then the corresponding uncertainty in height can be estimated from the hydrostatic equation:

$$\frac{dp}{p} = -\frac{g}{RT}dZ$$

For $\delta p = 0.5$ mb, $p = 500$ mb, $T = 263$ K, gives $\delta Z = 7.5$ m.



More Information:

Contact Information:

email: cooperw@ucar.edu

phone: 303 497 1600

