

LI-820

CO₂ GAS ANALYZER

Instruction Manual

LI-COR[®]

Biosciences

LI-820
CO₂ Analyzer

Instruction Manual

LI-COR[®]

Federal Communications Commission
Radio Frequency Interference Statement

WARNING: This equipment generates, uses, and can radiate radio frequency energy and if not installed in accordance with the instruction manual, may cause interference to radio communications. It has been tested and found to comply with the limits for a Class A computing device pursuant to Subpart J of Part 15 of FCC rules, which are designed to provide a reasonable protection against such interference when operated in a commercial environment. Operation of this equipment in a residential area is likely to cause interference in which case the user, at his own expense, will be required to take whatever measures may be required to correct the interference.

LI-COR

Biosciences

■ LI-COR, inc.
Environmental
4421 Superior Street
P.O. Box 4125
Lincoln, Nebraska 68504 USA

■ Phone: 402-467-3576
FAX: 402-467-2819
Toll-free: 1-800-447-3576 (U.S. & Canada)
E-mail: envsales@licor.com

Declaration of Conformity

Manufacturer's Name: LI-COR Inc.

Manufacturer's Address: 4421 Superior Street
Lincoln, Nebraska USA 68504

declares that the product

Product Name: Infrared Gas Analyzer

Model Number(s): LI-820

Product Options: None

conforms to the following Product Specifications:

FCC CFR Part 15.109 Radiated Emissions, Class A
FCC CFR Part 15.107 Conducted Emissions, Class A

IEC 61326 : 1997/A2:2001 Radiated Emissions, Class A
IEC 61326 : 1997/A2:2001 Conducted Emissions, Class A
IEC 61000-4-2 : 1995/A2:2000: ESD, 4kV/8kV Contact/Air
IEC 61000-4-3 : 1995/A2:2000: Radiated RF Immunity, 10V/m
IEC 61000-4-4 : 1995/A2:2000: EFT/Burst
IEC 61000-4-5 : 1995/A2:2000: Surge
IEC 61000-4-6 : 1996/A1:2000: Conducted RF Immunity
IEC 61000-4-8 : 1993/A2:2000: H-Field Immunity, 30A/m
IEC 61000-4-11 : 1994/A2:2000: Voltage Dips

Supplementary Information:

The product herewith complies with the requirements of the EMC Directive 89/336/EEC.



Dave Dilley
Director of Engineering

Document #53-06935
February 1, 2002

NOTICE

The information contained in this document is subject to change without notice.

LI-COR MAKES NO WARRANTY OF ANY KIND WITH REGARD TO THIS MATERIAL, INCLUDING, BUT NOT LIMITED TO THE IMPLIED WARRANTIES OF MERCHANTABILITY AND FITNESS FOR A PARTICULAR PURPOSE. LI-COR shall not be liable for errors contained herein or for incidental or consequential damages in connection with the furnishing, performance, or use of this material.

This document contains proprietary information which is protected by copyright. All rights are reserved. No part of this document may be photocopied, reproduced, or translated to another language without prior written consent of LI-COR, Inc.

© Copyright 2002, LI-COR, Inc.

Publication Number 984-06557

Printing History

New editions of this manual will incorporate all material since the previous editions. Update packages may be used between editions which contain replacement and additional pages to be merged into the manual by the user.

The manual printing date indicates its current edition. The printing date changes when a new edition is printed. (Minor corrections and updates which are incorporated at reprint do not cause the date to change).

LI-COR, Inc. ● 4421 Superior Street ● Lincoln, Nebraska 68504

Phone: 402-467-3576 ● FAX: 402-467-2819

Toll-free: 1-800-447-3576 (U.S. & Canada)

e-mail: envsales@licor.com ● www.licor.com

Table of Contents

Section 1. General Description

What's What	1-1
Features	1-3
Precautions	1-3
Getting Started Tutorial	1-4

Section 2. Power On

Power On	2-1
Low Battery Indicator	2-1
Alarms	2-2

Section 3. Operation

Installing the PC Communications Software on Your Computer	3-1
Setting the Communication Parameters	3-2
Cabling	3-2
RS-232 Output	3-2
Initial Setup	3-3
Using the Toolbar	3-6
Settings Window - Setting Operational Parameters	3-7
Options	3-9
Enable Heater	3-9
Pressure Compensation	3-9
Filter	3-9
Alarms	3-9
Span Range	3-9
DACs	3-10
Using the Terminal Strip	3-14
Charting Window	3-16
Diagnostics Window	3-19
Logging Data	3-20
Calibration Window - Setting the Zero and Span	3-24
Connecting the LI-820 to the LI-1400 Data Logger	3-27

Section 4. Theory of Operation

System Overview.....	4-1
Optical Bench System	4-2

Section 5. Maintenance

Cleaning the Optical Bench.....	5-1
Changing the Optical Bench	5-5
Changing the Fuse	5-7

Appendix A. Specifications

Appendix B. Pin Assignments

Appendix C. List of Suppliers

Appendix D. Configuration Grammar

Warranty

1

General Description

What's What

This procedure should be followed if you have just taken delivery of your LI-820. Check the packing list to verify that you have received everything that was ordered and that you have also received the following items:

- **RS-232 Cable** - (Part #392-04993), used to connect the LI-820 to your computer.
- **820-500 Data Communications Software** - This Windows® 95/98/NT/2000/XP/ME compatible software is used to communicate with your computer. The software is provided on CD. A complete description of this software can be found in Section 3, *Operation*.

Section 1

- **Standard Spare Parts Kit (9980-012)** - This kit contains replacement parts for your LI-820. As you become familiar with the analyzer you will learn which items to keep close at hand and which items can be stored away. The spare parts kit contains these items:

Description	Qty.	LI-COR Part No.
Polyurethane Mounting Feet	4	234-02268
Mounting Screws	4	149-02610
Terminal Block	1	250-05340
Bev-a-line Tubing	12'	222-01824
Balston Disposable Air Filter	2	300-01961
Quick Connect Unions	2	300-03123
Rapid Tube Fitting Nut	2	9861-036
1.6A Fuse	2	439-04537
Cleaning Kit, includes:	1	9980-013
3" Cleaning Swabs	5	610-05314
5" Cleaning Swabs	5	610-05315
O-Rings	4	192-00226
Pre-formed Optical Bench Tubing	4	6580-010

Features

The LI-820 is an economical high performance, non-dispersive infrared gas analyzer designed to be used for a wide variety of applications. Some of the LI-820's important features include:

- Optional short (2") and standard long (5.5") interchangeable optical benches can be used to obtain resolutions of 0-20000 ppm and 0-2000 ppm, respectively. No changes in calibration polynomials or software need to be made when swapping optical benches; you may need to recalibrate the instrument, however.
- Optical benches are fully serviceable by the user; cleaning the optical benches is a simple process, and does not affect the instrument calibration.
- Simple Windows[®] software provides for easy user calibration and data output.

Precautions

- The optical bench is maintained at a constant 50 °C. Avoid direct exposure to sunlight or extremely high temperatures that may elevate the temperature inside the LI-820 case.
- The optical source is sensitive to vibration, and can be damaged by strong vibrations or jarring. Do not drop the LI-820, or expose it to severe mechanical shock.

- Do not use abrasive cleansers when cleaning the optical bench, as damage to the gold plating may result. Instructions for cleaning the optical bench can be found in Section 5.
- Always filter air entering the LI-820. Two Balston filters are included in the spares kit.

Getting Started Tutorial

The following section briefly covers the basic steps you might follow to set up the LI-820 to collect and record data. Many of these steps are described in greater detail throughout this manual.

1

Install the 820-500 PC Communications Software.

This software is used to set the zero and span of the LI-820 and to set up data communication and data transfer parameters. Installation instructions can be found in Section 3, *Installing the Software on Your Computer*.

2

Determine your jumper settings for high and low alarm output, if required.

There are 2 jumpers inside the LI-820 case (on the main circuit board) which toggle the high and low alarm output between 0-5V (TTL levels) and an open drain condition.

The default jumper positions are set for 0-5V output for both high and low alarms. This alarm configuration is suitable for logic devices such as dataloggers. To use the high and/or low alarms to operate a relay switch, the jumpers should be reconfigured for open drain output. See Section 2, *Alarms*, for a description of how to change the alarm jumper settings.

If the default jumper positions are suitable for your application, or if you do not intend to use the alarms, proceed to Step 3.

3

Connect a power source to the LI-820.

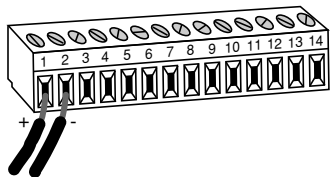

The LI-820 requires an input voltage of 12-30 VDC. The power supply must be able to source a maximum current drain of 1.2A (at 12 VDC). After the instrument has warmed up it will draw about 0.3A (at 12 VDC) with the heaters on. Bare wire leads are connected to the terminal strip at positions 1 and 2. Connect the positive lead to position #1 (12-30VDC), and the negative lead to position #2 (GND).

NOTE: Pull straight out on the face of the terminal strip to remove it; this can make it easier to connect the wires.

4

Connect the RS-232 cable.

Connect one end of the serial cable to the 9-pin Serial I/O port on the LI-820 front panel, and the other end to a serial port on your computer. If you want to interface to a device with a 25-pin serial port, a 9-pin to 25-pin adapter must be used; a gender changer may be required in some cases, also. Tighten the two screws on the ends of the serial cable.

5

Connect other output device(s) if desired.

Output devices such as dataloggers and relay switches for high and low alarms are connected via the terminal strip. A complete description of the terminals can be found in Section 3, *Using the Terminal Strip*.

6

Hook up the input air stream and external filter.

Remove the nut from the Flow In fitting and connect a short (12" or so) piece of Bev-a-line tubing (in the spares kit). Tighten the nut. Place a Balston filter (also in the spares kit) in the sample airstream before it enters the **FLOW IN** port on the LI-820.

IMPORTANT: *Always install the external air filter before operating the LI-820. Insert filter into the input airstream before it enters the LI-820. Failure to do this will lead to contamination of the optical path.*

There are some quick connect fittings in the spare parts kit that can be used on either side of the Balston filter to aid in changing the filter out. Press on the red part of the fitting to release the tubing.

When using the LI-820 for applications where sample air is particularly dirty, you may consider stacking two filters in series. For maintenance, replace the filter furthest upstream from the analyzer with the filter closest to the analyzer and replace the filter closest to the analyzer with a new filter.

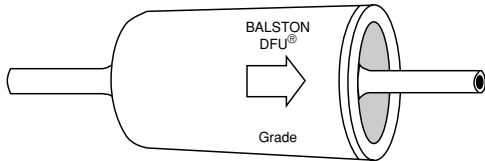

Install the new filter(s) with the arrow facing *toward* the **FLOW IN** port.

The air inlet and outlet ports should be covered with the dust caps provided or attached to an air line when the instrument is not in use. This will prevent dust from entering the instrument downstream from the filters where it can enter the optical path.

Replacement Balston air filters can be obtained from LI-COR (part #300-01961).

7

Start the 820-500 PC Communications Software.

Click on the program icon to start the 820-500 program. The 820-500 Main window appears. Select **Connect** from the File menu. Choose the serial port to which the LI-820 is connected, and the data output interval. Select the COM port and the data output interval, if desired, and click the **Connect** button. If the analyzer is connected properly, data will appear in the main window.

8

Configure the analyzer.

Select **Settings** from the View menu. The Settings window appears. Select the CO₂ range (the 'Span Range' radio buttons) over which you will be measuring CO₂. Choose a value for signal averaging (the Filter field), between 0 and 20 seconds. Set values for high and low alarms and corresponding dead bands, if desired. See Section 2 for a complete description of the alarms. If you are using an output device to collect data, choose the value to be output at DAC 1 and/or DAC 2. Make sure the Heater and Pressure Compensation buttons are enabled (checked), and click **OK**.

9

Set the analyzer zero.

Connect a dry, CO₂-free gas to the input air stream. Select **Calibration** from the View menu. Click on **Zero**. After about a minute, a message will appear that indicates the IRGA is zeroed.

10 Set the analyzer span.

Connect your span gas to the input air stream. *Note that your span gas concentration must not exceed the span range chosen in the Settings dialog from Step 8 above.* Enter the value of the span gas. Click on **Span**. After a few minutes, a message will appear indicating the span calibration is completed. Click **Close**.

11 Set up the logging parameters.

Select **Options** from the Logging menu. Choose the File Header(s) to be output with the data, the values to be logged, the field delimiter, and log frequency. Click **OK**. Choose **Start** from the Logging menu. Enter a file name for the data file. Click **Save**.

12 Set up the charting parameters, if desired.

Select **Charting** from the View menu. Enter the Y-Axis min and max values, X-Axis max, and time units to be displayed on the plot. Click **Start** to begin recording data. A graph with data will appear in the window and data will be logged to the file designated in Step 11 above.

13 Choose **Stop** from the Logging menu to close the data file and stop recording when you are done collecting data.

2

Power On

Power On

The LI-820 can be connected to a constant source of AC power using a transformer that provides 12-30VDC (12W minimum) to the LI-820. If the LI-820 is powered On with a battery below 10.5 volts, the analyzer will not power up, and the Low Battery LED on the top panel will illuminate.

Low Battery Indicator

The low battery LED on the LI-820 top panel will illuminate when the battery voltage drops below 10.5 volts. The LI-820 will continue to operate with a low battery; there will, however, be a corresponding reduction in performance.

Alarms

The LI-820 is equipped with high and low alarms, which can be configured as open collector or 0-5V output (TTL levels) using jumpers on the main PC board (Figure 2-1). The default configuration is 0-5V output. Figure 2-2 shows the position of the jumpers for each of the two alarm conditions.

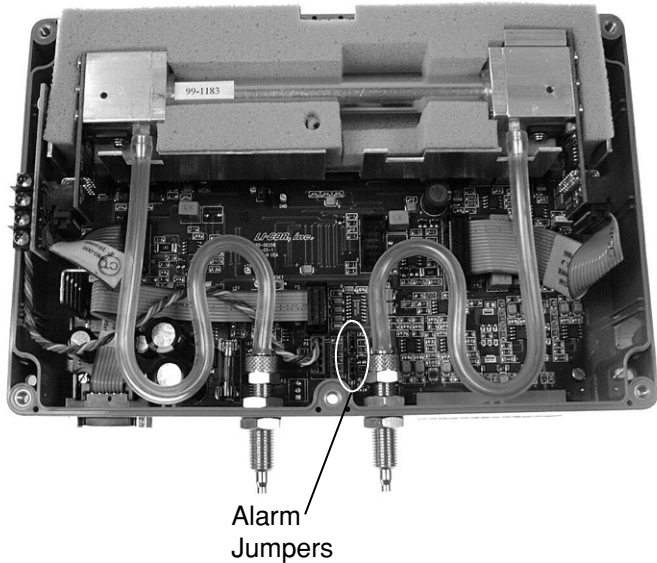

Figure 2-1. Location of alarm jumpers LK1 and LK2.

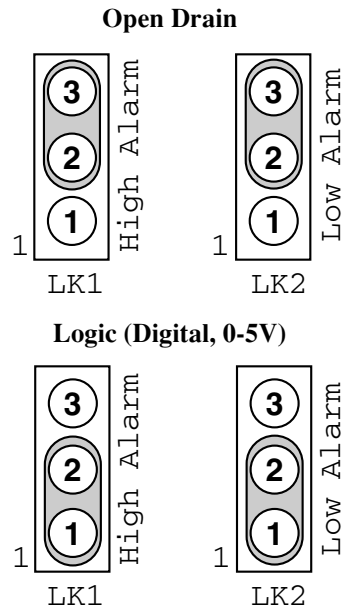
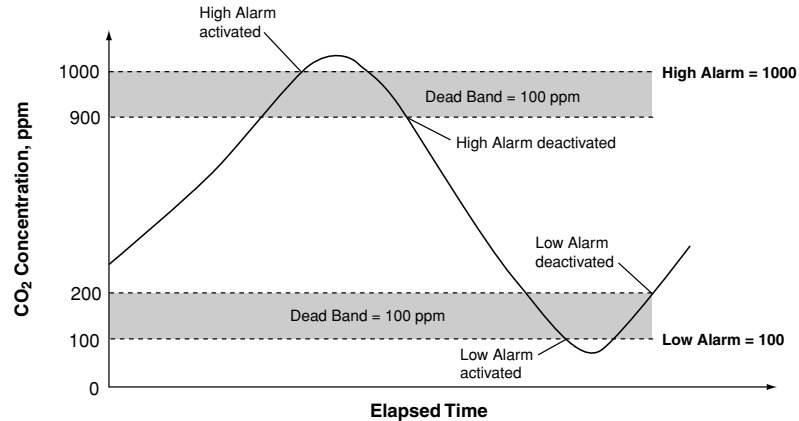

Figure 2-2. Position of jumpers for open drain and 0-5V output.

In addition, a "dead band" value can be set in software for both high and low alarms. To understand how the alarms and dead band values work, look at the diagram below.



In this chart, the low and high alarm values are set to 100 ppm and 1000 ppm, respectively. The dead band value in both alarms is set to 100 ppm. When the CO₂ concentration reaches 1000 ppm, the high alarm is activated, and remains active until the concentration drops below 900 ppm. When the CO₂ concentration falls below 100 ppm, the low alarm is activated, and remains active until the concentration rises above 200 ppm. Your choice for the dead band value(s) depends on your application, and the fluctuation in CO₂ concentrations over time.

Note: Increasing the signal average value in software (see *Settings Window; Options; Filter* in Section 3) can help reduce fluctuations in readings.

Alarm LEDs can be viewed on the top panel of the LI-820. Terminals 3 and 5 on the terminal strip are also connected to the High and Low alarms, respectively. This is useful in cases where you want to connect an audible alarm, for example, or a relay switch to operate another device that will raise or lower the CO₂ concentration to the desired level. The schematic diagram below shows how the high alarm could be connected to a relay switch that triggers an exhaust fan in a greenhouse environment. These relays could also be used to trigger devices such as automatic dialers, alarms, pumps, and valves in industrial and other environments.

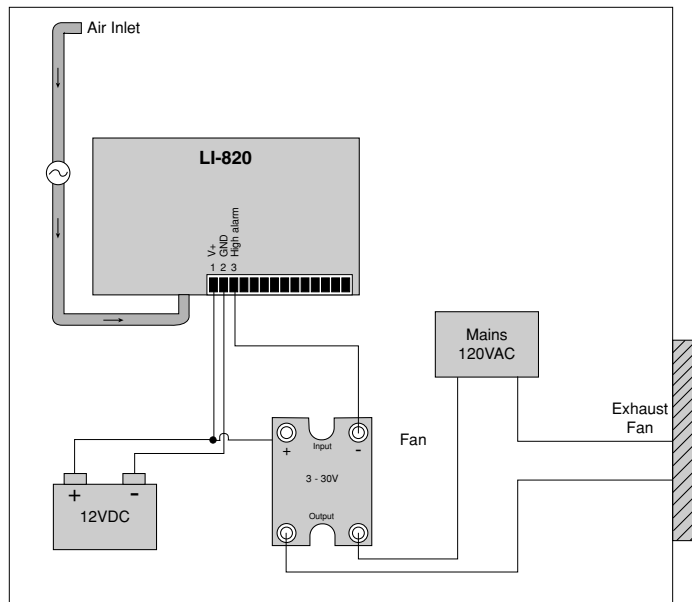

A list of suppliers of electronic relay switches can be found in Appendix C.

NOTE: Consult your local electrical codes before wiring, and/or have a professional electrician wire your application.

3 Operation

Installing the PC Communications Software on Your Computer



The 820-500 software is shipped on CD. It requires that your computer have an RS-232 serial (COM) interface, and Windows® 95/98/NT/2000/XP/ME. The program runs on any true PC-compatible computer.

An installation menu starts when you insert the CD into your CD-ROM drive. Select *Install Software* from the menu and follow the instructions. If installation does not start, select **Run** from the Windows *Start* menu, and select the LI820Setup.exe file on the CD. When the software has finished the installation procedure, a program icon will be placed in the Programs menu.

NOTE: To remove the software, go to the Control Panel and select *Add/Remove Programs*. Choose LI820 from the list of programs and click the Add/Remove button.

Setting the Communication Parameters

LI-820 communication parameters are set automatically when the program is run.

Cabling

The serial cable included has 9-pin connectors on both ends; either end plugs into the 9-pin connector (Serial I/O) on the front panel of the LI-820. Use this cable to interface with your computer's 9-pin serial port. If you want to interface to a computer with a 25-pin serial port, a 9-pin to 25-pin adapter must be used.

RS-232 Output

Data from the LI-820 can be transferred to a computer for analysis, printing or storage using the RS-232 interface. The LI-820 RS-232 port is configured as Data Terminal Equipment (DTE) with no hardware handshaking, and is bi-directional, meaning information can be transferred both into and out of the LI-820.

The 820-500 PC Communication Software that comes with the LI-820 is used to transfer data and setup files between the analyzer and the PC.

Initial Setup

Click on the LI-820 program icon to start the program. The LI-820 Main Window appears. Select **Connect** from the File menu. You are asked to select the serial port to which the LI-820 is connected, and the output interval at which data are output (0.5 to 20 seconds, in 0.5 second increments).

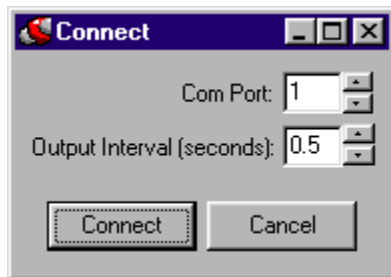

Choose a port and the output interval and click **Connect**. If the instrument is connected properly, data will begin to appear in the window:

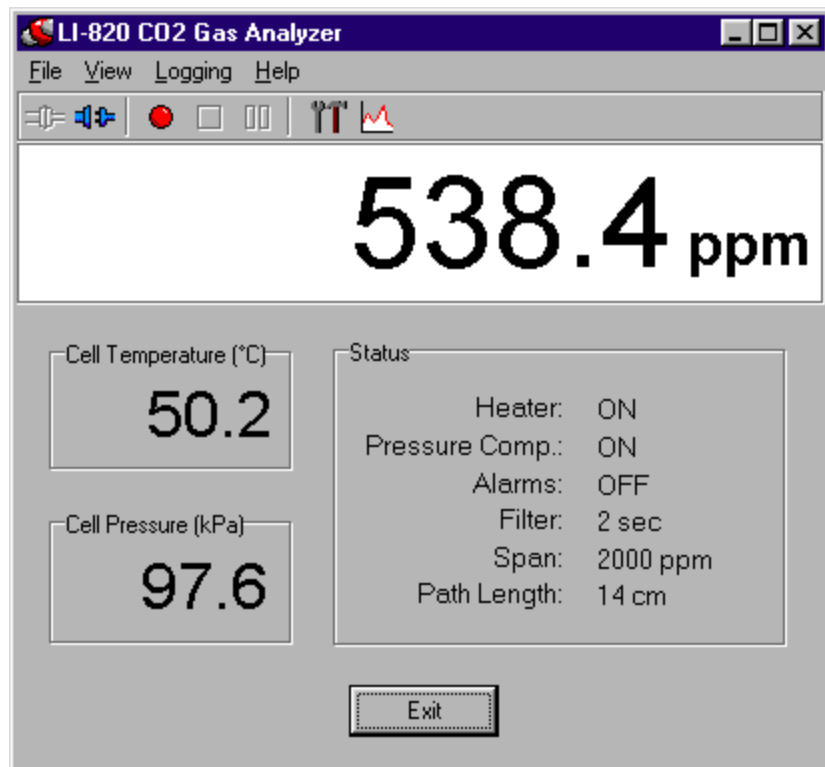

The Main window displays the CO₂ concentration (ppm), as well as the status of various LI-820 parameters. There are also three menus used to configure the LI-820, perform zero and span calibrations, and set up the parameters for recording data. The LI-820 parameters in this window are as follows:

Parameter	Description
Cell Temperature	Temperature (°C) in the LI-820 optical cell. This value should remain near 50 °C when the heater is turned ON.
Cell Pressure	Barometric pressure (kPa) measured in the LI-820 optical cell. This value can be used to correct CO ₂ measurements for the effects of pressure fluctuations on gas density and band broadening.
Heater	Shows status of heater (ON/OFF), which is used to maintain the optical cell at a constant 50 °C. The heater is turned ON/OFF in the Settings window.
Pressure Comp.	Shows whether pressure compensation is ON/OFF. When ON, CO ₂ measurements are corrected for the effects of pressure fluctuations on gas density and band broadening.
Alarms	Shows status of High and Low alarms, whose values are set in the Settings window. Alarms are enabled (ON), or disabled (OFF).

Section 3

Parameter	Description
Filter	Shows the current value for software signal averaging, set in the Settings window. The filter can be set from 0 (no signal averaging) to 20 seconds.
Span	Displays the span range currently selected. With the 14 cm optical bench, span ranges of 0-1000 or 0-2000 can be selected. With the 5 cm optical bench, span ranges of 0-5000 or 0-20000 can be selected.
Path Length	Shows the size of the optical bench installed in the LI-820, either 5.5 inches (14 cm), or 2 inches (5 cm).

Using the Toolbar

The toolbar in the Main window contains shortcuts for some of the commonly used menu items:

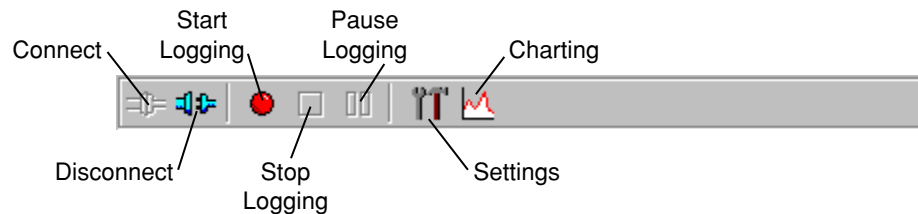

Settings Window - Setting Operational Parameters

The Settings window contains parameters related to initial setup of the LI-820, including the resolution of the optical bench, signal filtering, high and low alarm setup, heater and pressure compensation options, and DAC output sources. Choose **Settings** from the View menu (or click on the toolbar icon) to open the Settings window:

Section 3

The heater should be enabled to maintain the optical bench at a constant 50 °C. Pressure compensation and DAC offset are optional parameters.

Software signal filtering is available from 0-20 seconds.

Disable the alarms here, or set high and low alarm values, and high and low dead band values.

The screenshot shows a 'Settings' dialog box with four main sections: Options, Span Range, Alarms, and DACs. The 'Options' section has 'Enable Heater' and 'Pressure Compensation' checked, and a 'Filter' dropdown set to '2 Sec'. The 'Span Range' section has radio buttons for '0 to 1000 ppm', '0 to 2000 ppm' (selected), '0 to 5000 ppm', and '0 to 20000 ppm'. The 'Alarms' section has 'Enable Alarms' checked, with input fields for 'High Alarm: 1600', 'High Dead Band: 100', 'Low Alarm: 700', and 'Low Dead Band: 100'. The 'DACs' section has a 'Range' dropdown set to '0.0v - 2.5v' (selected), and 'DAC 1 Source' and 'DAC 2 Source' dropdowns set to 'CO2' and 'Cell Pressure' respectively. 'OK' and 'Cancel' buttons are at the bottom.

Range of optical bench. 5000 and 20000 ppm will be greyed out if 5.5" optical bench is installed. Similarly, 1000 and 2000 will be greyed out if 2" bench is installed.

DAC output range. Choose source to be output to DAC 1 (terminal strip connector #9), and/or DAC 2 (terminal strip connector #7).

Options

Enable Heater

The Heater should be enabled to maintain the optical bench at a constant 50 °C.

Pressure Compensation

Enable the Pressure Compensation check box to automatically correct gas concentration values for changes in cell pressure. In most cases this should be turned on; disabling this feature means that no pressure correction is desired in the gas concentration calculations, which can lead to erroneous measurements.

Filter

Shows the current value for software signal averaging. The filter can be set from 0 (no signal averaging) to 20 seconds.

Alarms

Allows you to enable/disable the alarms, and enter high, low, and dead band values. A complete discussion can be found in *Section 2, Alarms*.

Span Range

The span range buttons determine the maximum CO₂ range over which the LI-820 will make measurements. If the 14 cm (5.5") optical bench is installed, 5000 ppm and 20000 ppm will be greyed out. Similarly, if the 5 cm (2") optical bench is installed, 1000 ppm and 2000 ppm

will be greyed out. Note that there are two benefits to selecting the 0-1000 ppm range if this range is adequate for your experiment. First, the narrower range provides better resolution in terms of the digital-to-analog converter (DAC). Each step of the DAC is able to resolve twice as many data points as compared to the 0-2000 ppm range, which results in better resolution. Secondly, the 0-1000 ppm range has a unique 4th order polynomial, which provides a better "curve fit", and ultimately improved accuracy over this range.

Note that your span gas concentration must not exceed the selected span range (1000, 2000, 5000, or 20000 ppm).

DACs

Analyzer output for up to 2 values (CO₂, Cell Temperature, or Cell Pressure) can be recorded by connecting a logging device to the terminal strip on the front of the analyzer. Output is linear, and is selectable at 0-5V or 0-2.5V. Choose the output range and the source for DAC 1 and/or DAC 2. Available output sources are CO₂, Cell Temperature, and Cell Pressure.

The DACs in the LI-820 are bipolar, and will go slightly negative (~-0.100V). This can happen, for example, if the cell becomes contaminated or just from small random perturbations when the CO₂ concentration is near zero. See Section 5, *Cleaning the Optical Bench* for instructions on cleaning the cell should it become contaminated.

Voltage output is measured by attaching the positive lead from the logging device to terminal 9 (V Out 1), or terminal 7 (V Out 2) on the LI-820 terminal strip. Connect the negative lead to position 10, (GND), or position 8.

The CO₂ concentration can be calculated from the DAC output voltage as follows:

$$\text{CO}_2 = V \left(\frac{C_{\text{range}}}{V_{\text{range}}} \right) \quad 3-1$$

where V is the measured voltage, C_{range} is the maximum value of the CO₂ range selected (0 to 1000 ppm, 0 to 2000 ppm, etc.), and V_{range} is the maximum DAC output for the selected range (0-5V or 0-2.5V).

Example: The voltage output is set for 0-5V output (V_{range}), the maximum CO₂ range chosen is 2000 ppm (C_{range}), and the measured output voltage (V) is 2.9V. To calculate the CO₂ concentration (no offset) from Equation 3-1 above,

$$\text{CO}_2 = 2.9V \left(\frac{2000 \text{ ppm}}{5V} \right) \quad 3-2$$

$$= 1160 \text{ ppm.}$$

Converting Voltage Output to Cell Temperature

Cell temperature can be calculated from the DAC output voltage as follows:

$$\text{Temp.} = V \left(\frac{100 \text{ }^\circ\text{C}}{V_{\text{range}}} \right) \quad 3-3$$

where V is the measured voltage output and V_{range} is the maximum DAC output for the selected range (5.0 or 2.5 volts).

Converting Voltage Output to Cell Pressure

Cell pressure can be calculated from the DAC output voltage as follows:

$$\text{Pressure} = V \left(\frac{115 \text{ kPa}}{V_{\text{range}}} \right) \quad 3-4$$

where V is the measured voltage output and V_{range} is the maximum DAC output for the selected range (5.0 or 2.5 volts).

Converting Current Output to ppm CO₂

Current output can be measured by connecting the positive input of the data logging device to positions 11 or 13 (4-20 mA 1 or 4-20 mA 2), and the negative input to position 12 or 14 (GND). The current output at positions 11 and 13 is non-isolated, and is rated to drive a 250 ohm load.

To convert current output (I) to units of ppm CO₂ in your computer or other output device, the following equation can be used:

$$\text{CO}_2 = \frac{C_{\text{range}}}{16}(I - 4) \tag{3-5}$$

where C_{range} is the maximum available CO₂ resolution (1000, 2000, 5000, or 20000 ppm), and I is the measured current output in mA.

Example: You have chosen 2000 for the range of the LI-820. The measured current output is 16.25 mA. To convert to ppm CO₂:

$$\begin{aligned} \text{CO}_2 &= \frac{2000}{16}(16.25 - 4) && \text{3-6} \\ &= \mathbf{1531.25 \text{ ppm}.} \end{aligned}$$

Using the Terminal Strip

The terminal strip is located on the front panel of the LI-820. To connect the wires, insert the bare wire end into the appropriate terminal and tighten the screw above that terminal using the small flat head screwdriver in the spare parts kit. The front face of the terminal strip can be removed to aid in connecting the wires by pulling straight out on the face.

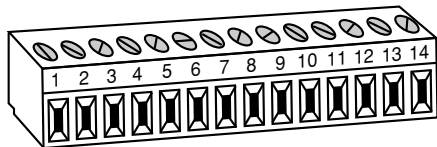

The terminal positions are as follows, reading left to right:

Terminal	Label	Description
1	12-30 VDC	Voltage In, 12-30 VDC
2	GND	Ground
3	High Alarm	High Alarm
4	GND	Ground
5	Low Alarm	Low Alarm
6	GND	Ground
7	V OUT 2	Voltage output channel 2
8	GND	Ground
9	V OUT 1	Voltage output channel 1
10	GND	Ground
11	4-20 mA 2	Current output channel 2
12	GND	Ground
13	4-20 mA 1	Current output channel 1
14	GND	Ground

Section 3

Charting Window

Select **Charting** from the View menu to open the Charting window (below). This is the window in which you can set up the parameters for plotting your data.

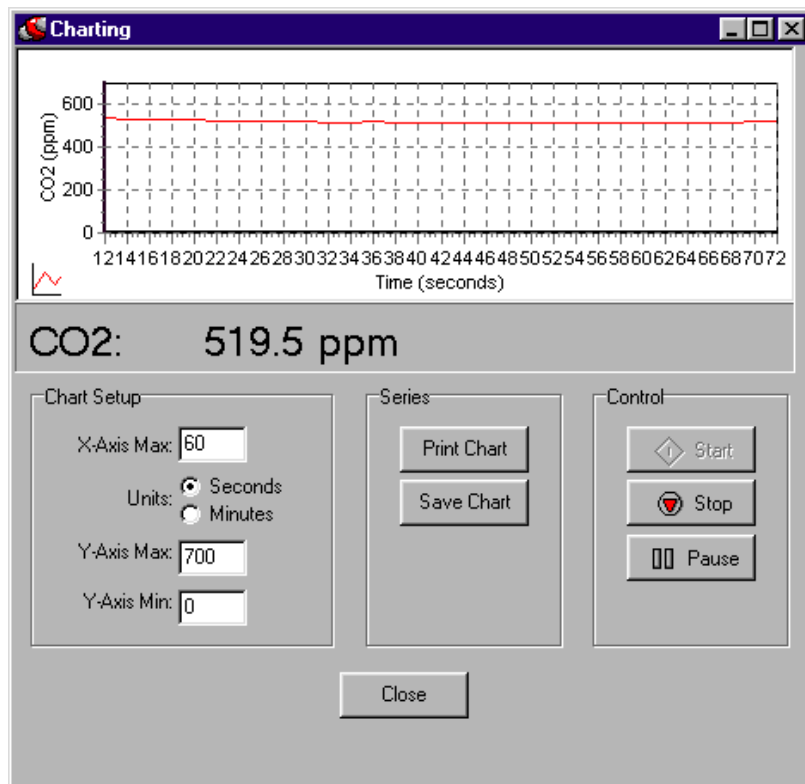

X-Axis Max

Sets the maximum value for the X axis (Time). The units for the X axis can be seconds or minutes.

Y-Axis Max/Min

Sets the maximum and minimum values for the Y axis (CO₂).

Press **Print Chart** to send the current chart to your printer. Press **Save Chart** to save the chart as a bitmap (.bmp) file.

Press **Start** at any time to view the chart layout and begin displaying data. Note that you must press **Stop** to make changes to the chart parameters, and then press **Start** again to resume data display.

Diagnostics Window

Select **Diagnostics** from the View menu to open the Diagnostics window (below). This window displays the current LI-820 internal software version number, the input voltage, and raw absorption value.

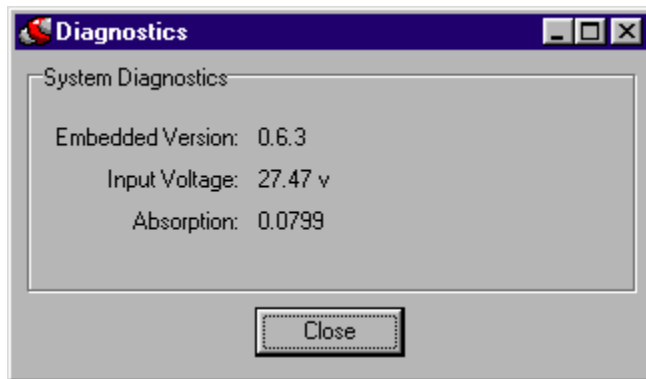

Logging Data

Start Logging

Opens the Log File Destination dialog, where you enter a file name for the data file. The file extension .txt is added automatically.



Stop Logging

Stops data logging.

Pause Logging

Pauses logging of data until **Start** is chosen from the Logging menu again, or the Start button on the toolbar is pressed.

Options

Opens the Logging Options window, where you can configure the data output options.

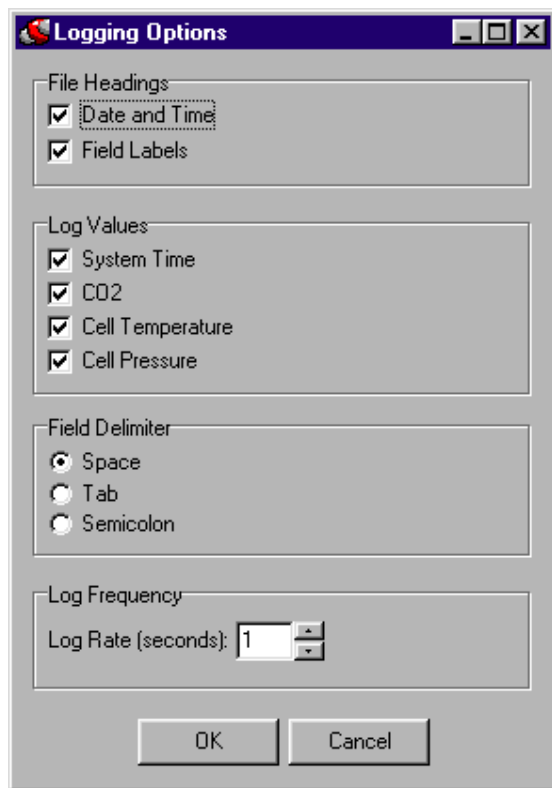

As configured above, the data output would appear similar to that shown below.

File Headings	"2001-12-19 at 14:41"			
	Time (H:M:S)	CO ₂ (ppm)	CellTemp (c)	CellPres (kPa)
Log Values	14:41:45	502.71	51.65	97.62
	14:41:46	502.60	51.65	97.62
	14:41:47	502.39	51.65	97.62
	14:41:48	502.48	51.65	97.62
	14:41:49	502.68	51.65	97.62
	14:41:50	502.57	51.65	97.62
	14:41:51	502.79	51.65	97.62
	14:41:52	502.92	51.65	97.62
	14:41:53	503.00	51.65	97.62
	14:41:54	502.88	51.65	97.62
	System Time (1s log rate)	CO ₂	Cell Temp.	Cell Pres.

Calibration Window - Setting the Zero and Span

Select **Calibration** from the View menu to open the Calibration window. This is the area in which you set the zero and span of the LI-820.

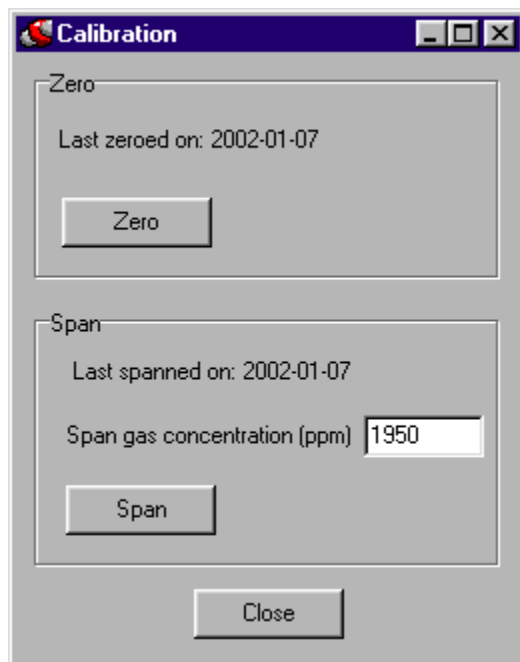

Section 3

It is recommended that you perform the zero calibration first, followed by the span calibration. To zero, flow a dry, CO₂-free gas through the LI-820, and make sure the optical cell is completely purged. Press the **Zero** button. The display will show ZERO, and the text in the Calibration window is greyed out. The zero will be set electronically, and the current date will be entered in the "Last zeroed on" field when completed.

To span, connect your span gas to the input air stream. Make sure the cell is purged, enter the value of the span gas, and click on **Span**.

The display will show SPAN, and the text in the Calibration window is greyed out. The span will be set electronically, and the current date will be entered in the "Last spanned on" field when completed.

Connecting the LI-820 to the LI-1400 Datalogger

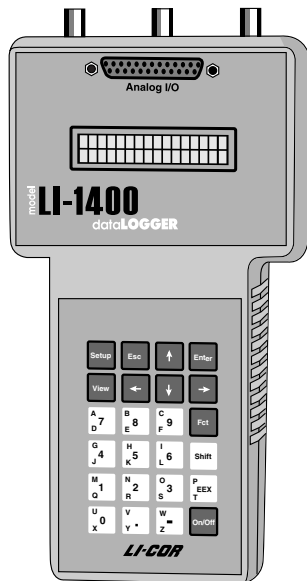

The following example shows how you can connect the LI-820 to a datalogging device such as the LI-COR Model LI-1400 DataLogger to collect analog data and convert to meaningful CO₂ values. As mentioned earlier, voltage output from the LI-820 is linear; converting analog CO₂ into ppm CO₂ simply requires multiplying the raw mV output by a conversion factor, which is dependent upon the selected voltage output range, and the maximum CO₂ resolution available (set in software at 0-1000 or 0-2000 ppm with the 5.5" optical bench, or 0-5000 or 0-20000 ppm with the 2" optical bench). In general, the conversion takes the form

$$\text{CO}_2 = V \left(\frac{C_{\text{range}}}{V_{\text{range}}} \right) \quad 3-7$$

where V is the measured voltage, C_{range} is the maximum value of the CO₂ range selected (0 to 1000 ppm, 0 to 2000 ppm, etc.), and V_{range} is the maximum DAC output for the selected range (0-5V or 0-2.5V).

For example, if the voltage output is set for 0-5V output, the maximum CO₂ range is 2000 ppm, and the measured voltage output is 2.9V, the equation would take the form

$$\text{CO}_2 = 2.9\text{V} \left(\frac{2000 \text{ ppm}}{5\text{V}} \right)$$

3-8

$$= \mathbf{1160 \text{ ppm.}}$$

This general equation can be converted into simple multipliers, based on the two known voltage output ranges, and the four values for maximum CO₂ resolution (1000, 2000, 5000 and 20000). This multiplier can then be entered in the data logging device to convert raw voltage to CO₂ values. Table 3-1 lists the appropriate values for this multiplier; simply choose your DAC output range in the second row, and then select the LI-820 maximum CO₂ range in the first column; follow across to find the appropriate multiplier.

Table 3-1. Multipliers for Converting Voltage Output to CO₂ Readings

	DAC Output Range	
	0-5V	0-2.5V
C_{range}	Multiplier (ppm/volt)	
0-1000 ppm	200	400
0-2000 ppm	400	800
0-5000 ppm	1000	2000
0-20000 ppm	4000	8000

The LI-1400 can be used to monitor voltage signals up to 2.5 volts with 76 microvolt resolution in real time and convert them into meaningful engineering units shown on the display. Alternatively, the LI-1400 can be configured to automatically log these data over extended periods of time and later dump the results to a computer for further analysis.

Access to the voltage channels require the 1400-301 Terminal block. Voltage channels are designated by the letter “V” and sequentially numbered V1-4. The lead from LI-820 terminal #7 or #9 should be attached to one of the LI-1400 terminals labeled V1, V2, V3, or V4, while the lead from terminal #8 or #10 should be attached to one of the LI-1400 terminals labeled ↓.

The following example shows how you can set up the LI-1400 Data Logger to collect raw voltage output from the LI-820 and convert to CO₂ values.

1. Set the voltage output of the LI-820 for 2.5V output as described in Section 3, *Analog Output*.
2. In the LI-1400, configure V1 channel as *General* for CO₂.
3. Enter a description, such as *CO2*.
4. Set Math = *Poly(nomial)* and press *Ent(er)*.
5. Set description as desired, $a1 = \text{multiplier from Table 3-2 above}$, $a0, a2-a5 = 0$. When finished, press *Esc* to return to the main configuration list.
6. Set *Oper(ator) = none*.
7. Enter a *Label* such as *ppm* for the units.
8. Set *Average=1 sec* or as desired. CO₂ will now be displayed on channel V1.
To log CO₂ automatically, follow the remaining steps:
9. Set *Log Routine* to the desired log routine.

10. Set $Calc=Mean$.
11. To capture the minimum and maximum CO_2 values, set $MinMax$ accordingly.
12. $TCcoef$ has no effect when $Calc=Mean$. It is used only when integrating.

4

Theory of Operation

System Overview

The LI-820 CO₂ Gas Analyzer is an absolute, non-dispersive, infrared (NDIR) gas analyzer based upon a single path, dual wavelength, infrared detection subsystem. The CO₂ measurement is a function of the absorption of IR energy as it travels through the optical path. Concentration measurements are based on the difference ratio in the IR absorption between a reference and sample signal. Reference and sample channels measure CO₂ in a single path through the use of narrow band optical filters with appropriately selected bands. The CO₂ sample channel uses an optical filter centered at 4.24 micrometers. This filter corresponds to the absorption band for CO₂. Concentrations of CO₂ present in the optical path will result in a reduction in IR energy as it traverses the optical path. The reference channel is established using a filter with a center wavelength at 3.95 micrometers. It follows that the out-of-band channel will experience no absorption due to CO₂ and thus serves as a reference since the detector receives the full energy of the source.

The instrument uses digital signal processing techniques to determine the temperature and pressure corrected CO₂ concentration based on the optical bench signals through the use of a ratio technique. The data are passed through a 6th order polynomial that performs linearization of the detector signal to a mole fraction mixing ratio of CO₂ in air given in μmol CO₂ per mole of air, or ppm.

Data output is provided in a digital format through an RS-232 interface that supports connection to an external computer. The instrument comes with a Windows® 95/98/NT/2000/XP/ME compatible application for instrument configuration, control, data collection and display. Analog signals are available through a terminal block for collection by a data logger or similar means. The instrument has an interchangeable optical path that allows for different concentration ranges as required by a particular application.

Optical Bench System

The LI-820 CO₂ Gas Analyzer optical path is a thermostatically controlled IR detection system. The optical bench operation is based upon a broad band IR source and a pyroelectric detector. The source is mounted in a parabolic reflector to collimate the light and increase energy throughput down the optical path to the detector. The reflector and optical path are gold plated to further increase energy transmission. The detector is a pyroelectric device that operates based on thermal energy received. The narrow band optical filters allow only the

two wavelengths of interest to illuminate the detector, allowing for the determination of CO₂ concentration in the presence of other infrared absorbing gases such as water vapor.

The detector operates responds to thermal energy, so it is necessary to precisely regulate the detector temperature. This allows for differentiation of thermal gradient noise from the received signals from the optical path. The detection subsystem is shown in Figure 4-1.

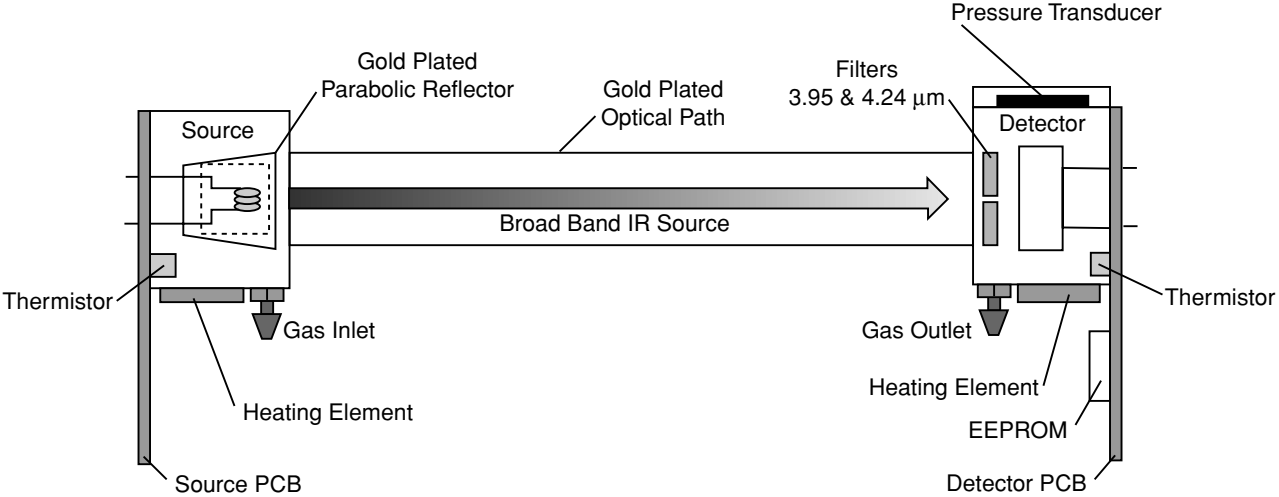

Figure 4-1. Schematic diagram of LI-820 optical bench.

The optical bench has a thermostat that maintains a constant operating temperature of 50 °C. A feedback loop is used to regulate the optical bench temperature. As shown in Figure 4-1, two thermistors, located in the source and detector housings, measure the present temperature. The thermistors are monitored as part of the control loop to determine corrections necessary in the thermal balance. Two heating elements are the sources of thermal energy into the source and detector housing. The optical path is in mechanical contact with the source and detector housing and thereby achieves thermal equilibrium.

The bench requires approximately 10 minutes to achieve the specified thermal temperature. A longer period of approximately 1.5 hours is required to bring the performance of the detection system to within 1 to 2% of reading. As shown in Figure 4-1, the detector housing has a pressure transducer integrated into the housing design. Part of the CO₂ concentration calculation depends on the pressure observed in the optical path, measured with an in-line pressure transducer. Many parameters can affect the pressure and thus the concentration reading. The processing center in the analyzer reads the pressure reading as part of its data collection task and uses this information in the concentration calculation. The gas flow enters the source housing, passes down the optical path and exits at the detector housing. The maximum flow rate for the analyzer is approximately 1 liter/min.

Another key parameter in the concentration calculation is the gas temperature in the optical path. It is assumed in the analyzer operation that the gas temperature will equilibrate to the optical bench temperature (50 °C) by the time it enters the optical path. Since the instrument performs temperature and pressure corrections as part of the concentration calculation, this assumption is very important. To cause the sample air to equilibrate to the optical bench temperature, an airflow pattern is created with sufficient eddy currents to cause thermal equilibration.

The optical bench is mounted in a foam enclosure to accomplish two purposes. The first is to assist in maintaining the controlled thermal environment required for the optical bench as described above. The second function of the foam enclosure is to protect the optical bench from mechanical shock and vibration that might damage the mechanically sensitive components. The foam enclosure is supported by an optical bench “tray” which is in turn attached to the main circuit board (PCB). The optical bench is mechanically de-coupled from the case by creating the s-bend in the Bev-a-line tubing from the external fittings to the optical bench gas inlet and outlet connectors. The electronic interface to the source and detector is achieved through printed circuit boards mounted directly to the source and detector housings, respectively. The PCBs connect the main PCB to the source and detector PCBs via a ribbon cable. This achieves the mechanical isolation desired for the optical bench.

Two optical benches are available, depending on the concentration range necessary for the particular application. The benches vary in length, resulting in different concentration ranges:

14 cm (5.5") Optical Bench

0 – 1000 ppm

0 – 2000 ppm

5 cm (2") Optical Bench

0 – 5000 ppm

0 – 20000 ppm

The ease of interchangeability for the optical bench options was a consideration from the beginning of the analyzer design. The foam enclosure is designed to accept either length bench while maintaining the two-fold purpose stated earlier. The electrical connections also support easy optical bench exchange as well as providing safe interconnection for proper operation. The main PCB contains two source headers and one detector header for connection to the source and detector PCBs via the ribbon cable. Combining the physical location of the two source headers with different ribbon cable lengths, the user can easily swap the optical benches and will be able to select the correct source header on the main PCB.

5

Maintenance

Cleaning the Optical Bench

The LI-820 optical bench can be removed and cleaned if necessary. If the optical path becomes dirty it may become difficult to span the analyzer. Excessive zero drift may also be observed if the optical path becomes dirty. Follow these steps to clean the optical bench:

1. Turn the LI-820 off. Remove the six screws on the LI-820 top panel and remove the cover. Note that these screws are not molded into the case and may fall out.
2. Unscrew the tube retaining nuts on the inner air port fittings. Remove the tubing from both air ports. Leave the tubing connected to the source and detector housings.
3. There are ribbon cables (Figure 5-1 below) connected to the circuit boards on the source and detector housings. Pull straight out on the connector that is attached to each ribbon cable. The optical bench can now be removed from the foam casing.

Section 5

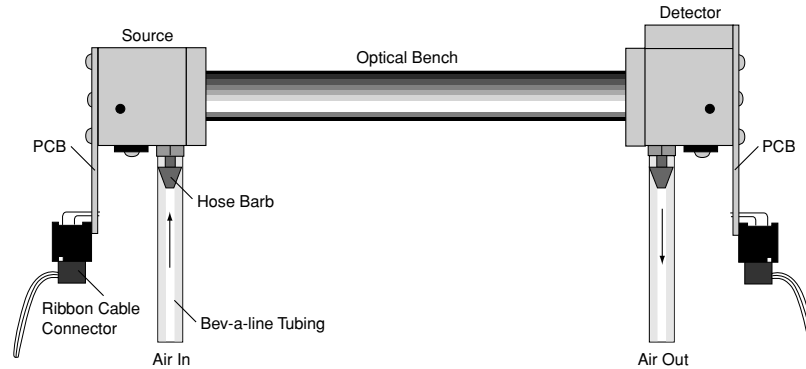

4. There are four screws on the source and detector circuit boards that must be removed. Remove the four screws in the corners of the boards, as shown below (they are slightly larger than the other four screws). Do not remove the remaining four screws.

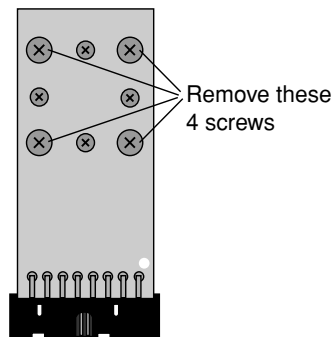

5. The source and detector housings (with attached circuit boards) can now be removed. The bench will appear as shown below. It is a good practice to replace the O-rings when cleaning or replacing the optical path.

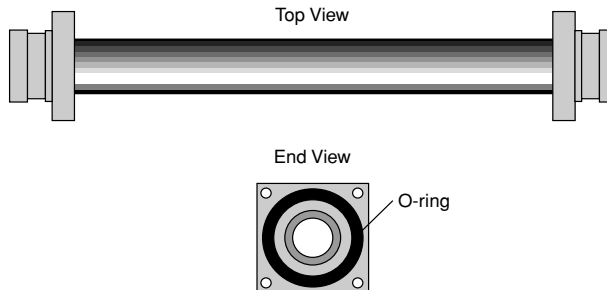

Section 5

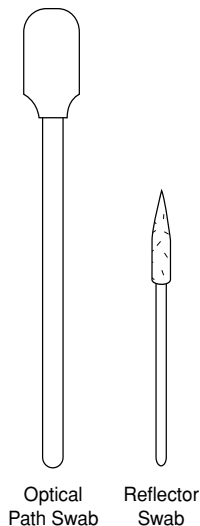

6. There are a number of swabs in the spare parts kit (see at left). Dip one end of the swab into a 50:50 ethanol/water solution and carefully swab both ends of the optical bench, until there is no more visible residue. A mild solution of dish washing type soap and water will also work. ***Do not use abrasive cleansers, as they can irreparably damage the gold plating on the optical bench.***
7. Use a reflector swab and carefully swab the gold-plated concave surface of the source housing, if necessary.
8. If you need to clean out the hose barbs and/or replace the tubing connected to the source and detector housings, use a small pair of diagonal cutters to remove the tubing from the hose barbs. Use the cutters to pinch the tubing parallel to the hose barb axis, and then pivot the cutters over the hose barb tip; the tubing will pull off of the hose barb. ***Be very careful not to cut the tubing or scratch the hose barb with the cutters, as subsequent tubing connections may leak.***
9. Let the optical bench dry. Re-assemble the bench, making sure the O-rings are in place on both ends of the bench. Note that the orientation of the cylinder is not important; either end can be inserted into the source or detector housing.
10. Re-assemble the LI-820 case. Make sure that the foam insulation on the inside top cover is positioned over the optical bench; it is required for thermal stability.
11. Perform zero and span calibrations as described in Section 3, *Calibration Window*.

Changing the Optical Bench

The 14 cm (5.5") and 5 cm (2") optical benches of the LI-820 can be interchanged to provide CO₂ measurements of 0-2000 and 0-20000 ppm, respectively. The LI-820 will automatically sense which optical bench is installed; no further software or hardware switches are required. To change the optical bench, follow these steps:

1. Follow Steps 1-5 above at *Cleaning the Optical Bench* to remove the existing bench and the source and detector housings.
2. Install the source and detector housings on the gold-plated optical path cylinder. Make sure that both source and detector housings have an O-ring installed, as shown in Step 5 above. The orientation of the cylinder is not important; either end can be inserted into the source or detector housing. **Note:** There is no need to grease the O-ring; simply press into place.
3. Carefully remove the 10-pin connector that was attached to the source housing circuit board from the main circuit board. Reattach the 10-pin connector to one of the connectors shown below, depending on which optical bench is being installed.

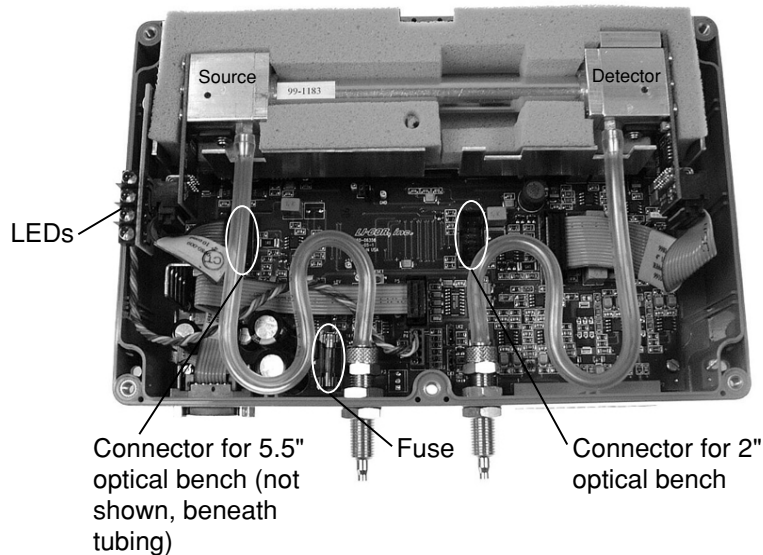

Figure 5-1. Location of 10-pin connectors for 5.5" and 2" optical benches.

4. Install the new bench in the same orientation as the existing bench, with the source side on the left as you face the front of the instrument.

5. Reattach the 10-pin connectors to the source and detector housing circuit boards. Reattach the Bev-a-line tubing to the hose barbs on the source and detector housings, and to the flow in and out ports, if necessary. Reassemble the case.
6. Perform zero and span calibrations as described in Section 3, *Calibration Window*.

Changing the Fuse

The LI-820 power supply is protected by a 1.6A 250V, 5 × 20 mm fast-blow type fuse located inside the case. If the battery fails to power the LI-820, and will not light the Power LED on the top panel, check to see if the fuse has blown.

To check the fuse, remove the six screws on the top of the LI-820. The fuse is located on the main circuit board, near the Flow In port, as shown in Figure 5-1. Replacement fuses (part #439-04537, in the spares kit) plug into the fuse holder; no soldering is required. Replace the fuse and reassemble the LI-820 case.

A

Specifications*

Measurement Range: 0 – 1000 ppm, 0 – 2000 ppm with 14 cm (5.5") optical bench
0 – 5000 ppm, 0 – 20000 ppm with optional 5 cm (2") optical bench

Measurement Principle: Non-Dispersive Infrared

Accuracy:

5 cm (2") Optical Bench (measurement range 0 - 20000 ppm):

P = 95 to 102 kPa 0 - 1000 ppm; $\pm 4\%$ of reading ± 10 ppm
1000 - 20,000 ppm; $\pm 4\%$ of reading

P = 50 to 113 kPa 0 - 1000 ppm; $\pm 6\%$ of reading ± 10 ppm
1000 - 20,000 ppm; $\pm 6\%$ of reading

14 cm (5.5") Optical Bench (measurement range 0 - 2000 ppm):

P = 95 to 102 kPa 0 - 200 ppm; $\pm 3\%$ of reading ± 5 ppm
200 - 2,000 ppm; $\pm 3\%$ of reading

P = 50 to 113 kPa 0 - 200 ppm; $\pm 5\%$ of reading ± 5 ppm
200 - 2,000 ppm; $\pm 5\%$ of reading

Zero Drift: < 1 ppm in 24 hrs at 350 ppm

Appendix A

Signal Noise: 3.0 ppm pk-pk noise @ 350 ppm (1 sec signal averaging)
1.0 ppm pk-pk noise @ 350 ppm (20 sec signal averaging)

Span Drift: < 3 ppm in 24 hrs at 350 ppm

Pressure Compensation Range: 150 mbars - 1150 mbars

Maximum Gas Flow Rate: 1 liter/minute maximum

Output Signals: 0 – 5V, 0 – 2.5V, 4 – 20 mA

DAC Resolution: 13-bits across specified range

Power Requirements: Input Voltage 12-30 VDC
1.2A @ 12V (14W) maximum during warm-up with heaters on.
0.3A @ 12V (3.6W) average after warm-up with heaters on.

Warm-Up Time: 1.5 hours

Operating Temp Range: -25 °C to +45 °C

Relative Humidity Range: -25 to 45 °C, 0 to 95% RH, Non-Condensing

Dimensions: 8.75" × 6" × 3" (22.23 × 15.25 × 7.62 cm)

Weight: 2.2 lbs. (4.84 kg)

* Specifications subject to change without notice.

B

Pin Assignments

DB-9 Connector

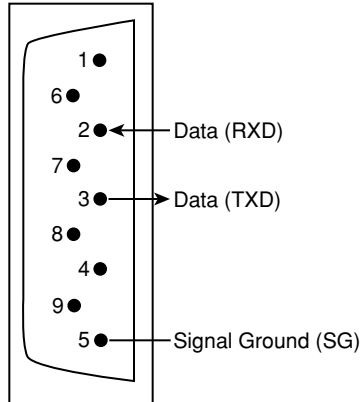



Suppliers

The company names, addresses, and phone numbers are the most current we have at the time of this printing. In some cases the information may change without notice.

Soda Lime (6-12 mesh) and Magnesium Perchlorate (Anhydrous) $Mg(ClO_4)_2$

GFS Chemicals

P.O. Box 245

Powell, OH 43065

Phone: 614-881-5501

FAX: 614-881-5989

Toll free: 800-858-9682

Soda Lime: Part #66352

$Mg(ClO_4)_2$: Part #49001 (500g,
<8% water)

Appendix C

Fisher Scientific

711 Forbes Avenue
Pittsburgh, PA 15219-4785
Phone: 201-467-6400
FAX: 201-379-7415
Toll free: 800-776-7000
Toll free FAX: 800-926-1166

Soda Lime: Part #S201-212
(LI-COR Part #9960-071)

Mg(ClO₄)₂: Part #M54-500 (500g)

Thomas Scientific

P.O. Box 99
Swedesboro, NJ 08085-6099
Phone: 609-467-2000
FAX: 609-467-3087
Toll free: 800-345-2100
Toll free FAX: 800-345-5232

Soda Lime: Part #C703-B76

Mg(ClO₄)₂: Part #C260-M61
(Dehydrite, 500g)

Electronic Relay Switches

Crydom Inc.

9525 Chesapeake Dr.
San Diego, CA 92123
800-827-9366
FAX: 619-715-7280

Potter & Brumfield Products Div.

**Siemens Electromechanical
Components, Inc.**
200 S. Richland Creek Dr.
Princeton, IN 47671-0001
info@ae.sec.siemens.com

D

Configuration Grammar

Introduction

The LI-820 communicates exclusively through a serial interface. The following discussion describes how to implement a synchronized communication protocol.

LI-820 Communications and XML

The configuration grammar used to communicate with the LI-820 is based upon a subset of the eXtensible Markup Language (XML). XML relies on the use of tags to "Markup", or give structural rules to a set of data.

A *tag* is a descriptive identifier, enclosed between a less than (<) and a greater than (>) symbol, used in part to describe a piece of data. For example, <NAME> is a tag that

describes a person's name. Each tag must have a corresponding end tag, denoted by '/'. Extending the example above, the end tag of `<NAME>` is `</NAME>`.

Elements are the basic unit of XML content. An element consists of a start tag and an end tag, and everything in between. For example, consider the following element:

```
<NAME>George</NAME>.
```

In this example, `<NAME>` (start tag) and `</NAME>` (end tag) comprise the markup, and "George" comprises the data. Because XML is extensible, tags can be defined specifically for the data they are meant to describe.

Elements can also contain other elements other than data.

```
<NAME>  
  <FIRST>George</FIRST>  
  <LAST>Smith</LAST>  
</NAME>
```

In this example, the outermost element `<NAME>` encompasses two other elements that contain data. All elements combined make up the XML document.

Connecting and Configuring Data Output

The LI-820 communicates through a serial port on the front of the instrument. This port is configured as follows:

Baud Rate: 9600 bps
Data Bits: 8
Parity: None
Stop Bits: 1
Flow Control: None

After a serial connection is established, the LI-820 will immediately send data out the serial port in the manner in which it was configured previously. In order to reconfigure the LI-820 to output specific data values, you must send the RS-232 portion of the XML grammar to the instrument with the desired values "turned on". To "turn on" the data value, set the value of the element to TRUE. As an example, the following string is sent to the instrument after a connection has been made between the computer (using the Windows® application software) and the LI-820:

```
<LI820>  
  <CFG>  
    <OUTRATE>{1}</OUTRATE>  
  </CFG>
```

```
<RS232>
  <STRIP>FALSE</STRIP>
  <ECHO>FALSE</ECHO>
  <CELL_TEMP>TRUE</CELL_TEMP>
  <CO2>TRUE</CO2>
  <CO2ABS>FALSE</CO2ABS>
  <CELLPRES>TRUE</CELLPRES>
  <IVOLT>TRUE</IVOLT>
  <RAW>FALSE</RAW>
</RS232>
</LI820>
```

Sending Data to the LI-820

To send data to the LI-820, each string must end with a '\n' to ensure that the LI-820 can parse consecutive commands.

After data have been sent to the LI-820, the instrument replies with:

```
<LI820><ACK>TRUE</ACK></LI820>
```

if the XML was received and parsed correctly. If there was an error in the XML, the following is sent:

```
<LI820><ACK>FALSE</ACK></LI820>.
```

For example, suppose that you would like to reconfigure the LI-820 to stop outputting cell temperature. Here is the command to send to the LI-820:

```
<LI820><RS232><CELLTEMP>FALSE</CELLTEMP></RS232></LI820>
```

If the command was received correctly, the LI-820 replies with

```
<LI820><ACK>TRUE</ACK></LI820>.
```

Reading Data From the LI-820

The LI-820 can send data continuously. To determine where one message ends and the next begins, each XML document sent from the LI-820 is delimited with a '\n' (0x10) character.

Polling the Current State of the LI-820

The LI-820 can be polled for individual sets of data by sending an XML document with a '?' in place of the set of elements requested. The element sets that can be requested include the data set, the current configuration, and the entire state of the instrument.

Sending this command:

```
<LI820><DATA>?</DATA></LI820>
```

instructs the LI-820 to send the most recent set of data values (as configured) as an XML document.

Sending this command:

```
<LI820><CFG>?</CFG></LI820>
```

instructs the LI-820 to send an XML document containing all of the configuration information, including heater status, filter settings, DACs, and alarms.

To receive the entire state of the instrument as an XML document, send this command:

```
<LI820>?</LI820>.
```

Calibration

The LI-820 calibration (zero and span) can be performed using XML grammar. This is accomplished in three steps:

1. Send the calibration command to the LI-820.

```

<LI820>
  <CAL>
    <DATE>{iso date}</DATE>
    <CO2ZERO>{bool}</CO2ZERO>
    <CO2SPAN>{int}</CO2SPAN>
  </CAL>
</LI820>

```

2. An acknowledgement is returned from the LI-820 if the command was accepted.

```

<LI820><ACK>TRUE</ACK></LI820>

```

3. After about a minute, all of the calibration information is returned from the LI-820, indicating that it has finished the zero and/or span.

```

<LI820>
  <CAL>
    <CO2LASTSPAN>{iso date}</CO2LASTSPAN>
    <CO2LASTZERO>{iso date}</CO2LASTZERO>
    <CO2KZERO>{float}</CO2KZERO>
    <CO2KSPAN>{float}</CO2KSPAN>
  </CAL>
</LI820>

```

If the calibration can not be performed, an ERROR is sent:

```
<LI820><ERROR>{Error Text}</ERROR></LI820>.
```

To Zero the LI-820

1. Send the XML command to initiate the zero.

```
<LI820>  
  <CAL>  
    <DATE>YYYY-MM-DD</DATE>  
    <CO2ZERO>TRUE</CO2ZERO>  
  </CAL>  
</LI820>
```

2. Wait for the acknowledgement.
3. Wait for the date to be returned to verify the zero operation succeeded. If the operation fails an <ERROR> will be sent.

To Span the LI-820

1. Send the XML command to initiate the span.

```
<LI820>
```

```
<CAL>  
    <DATE>YYYY-MM-DD</DATE>  
    <CO2SPAN>Gas Concentration</CO2SPAN>  
</CAL>  
</LI820>
```

2. Wait for the acknowledgement.
3. Wait for the date to be returned to verify the span operation succeeded. If the operation fails an <ERROR> will be sent.

LI-820 XML Grammar and Element Description

Data Types in the XML Grammar

{val | val |...}

The value will be a member of the specified set. | = or.

{bool}

Boolean values, TRUE | FALSE.

{float}

Floating point values in decimal or exponential notation.

{int}

Integers.

{iso date}

A date in the ISO format. 4 digit year - 2 digit month - 2 digit day.

Example: 2002-04-27.

XML Grammar

```
<LI820>
  <ACK>{bool}</ACK>
  <VER>{string}</VER>
  <DATA>
    <CO2>{float}</CO2>
    <CO2ABS>{float}</CO2ABS>
    <CELLTEMP>{float}</CELLTEMP>
    <CELLPRES>{float}</CELLPRES>
    <IVOLT>{float}</IVOLT>
    <RAW>{integer}</RAW>
  </DATA>
  <RS232>
    <CO2>{bool}</CO2>
    <CO2ABS>{bool}</CO2ABS>
    <CELLTEMP>{bool}</CELLTEMP>
    <CELLPRES>{bool}</CELLPRES>
    <IVOLT>{bool}</IVOLT>
    <STRIP>{bool}</STRIP>
    <ECHO>{bool}</ECHO>
    <RAW>{bool}</RAW>
  </RS232>
  <CFG>
```

```

<OUTRATE>{float}</OUTRATE>
<HEATER>{bool}</HEATER>
<PCOMP>{bool}</PCOMP>
<FILTER>{int}</FILTER>
<ALARMS>
    <ENABLED>{bool}</ENABLED>
    <HIGH>{int}</HIGH>
    <HDEAD>{int}</HDEAD>
    <LOW>{int}</LOW>
    <LDEAD>{int}</LDEAD>
</ALARMS>
<BENCH>{5 | 14}</BENCH>
<SPAN>{1000 | 2000 | 5000 | 20000}</SPAN>
<DACS>
    <RANGE>{2.5 | 5.0}</RANGE>
    <D1>{NONE | CO2 | CELLTEMP | CELLPRES}</D1>
    <D2>{NONE | CO2 | CELLTEMP | CELLPRES}</D2>
</DACS>
</CFG>
<CAL>
    <DATE>{iso date}</DATE>
    <CO2ZERO>{bool}</CO2ZERO>
    <CO2SPAN>{int}</CO2SPAN>

    or

    <CO2LASTZERO>{iso date}</CO2LASTZERO>
    <CO2LASTSPAN>{iso date}</CO2LASTSPAN>
</CAL>

```

```
<ERROR>{string}</ERROR>  
</LI820>
```

Element Description

Tag	Parent	Value(s)	Cardinality	R/W	Comments
<LI820>	N/A (root)	<DATA> <RS232> <CFG> <CAL> <ACK> <VER> <ERROR> ?	1-N		<LI820> is the root tag for all XML statements. LI-820 outputs entire configuration.
Examples: <LI820>?</LI820> <LI820><ACK>TRUE</ACK></LI820>					

Tag	Parent	Value(s)	Cardinality	R/W	Comments
<DATA>	<LI820>	<CO2ABS> <CELLTEMP> <CELLPRES> <IVOLT> <RAW> ?	1-N		<DATA> contains all data values sent from the LI-820. All of the elements within the DATA tag are readable only. A ? requests all data values to be output.
Examples: <LI820><DATA><CO2>2.34e2</CO2><IVOLT>1.5e2</IVOLT></DATA></LI820> <LI820><DATA>?</DATA></LI820>					

Appendix D

Tag	Parent	Value(s)	Cardinality	R/W	Comments
<CO2>	<DATA>	Float	1-1	R	CO2 in ppm
<CO2ABS>	<DATA>	Float	1-1	R	CO2 absorption
<CELLTEMP>	<DATA>	Float	1-1	R	Cell temperature
<CELLPRES>	<DATA>	Float	1-1	R	Cell pressure
<IVOLT>	<DATA>	Float	1-1	R	Input voltage
<RAW>	<DATA>	Text	1-1	R	Raw detector readings

Examples:

```
<LI820><DATA><CELLTEMP>5.16E1</CELLTEMP><CELLPRES>9.742E1</CELLPRES><CO2>6.17E2</CO2><CO2ABS>8.94E2</CO2ABS>DATA></LI820>
```

Tag	Parent	Value(s)	Cardinality	R/W	Comments
<RS232>	<LI820>	<CO2> <CO2ABS> <CELLTEMP> <CELLPRES> <IVOLT> <RAW> <ECHO>	1-N		Setting <RS232> values will determine what values are output in <DATA>

Tag	Parent	Value(s)	Cardinality	R/W	Comments
<CO2>	<RS232>	TRUE FALSE	1-1	R/W	CO ₂ in ppm
<CO2ABS>	<RS232>	TRUE FALSE	1-1	R/W	CO ₂ absorption
<CELLTEMP>	<RS232>	TRUE FALSE	1-1	R/W	Cell temperature
<CELLPRES>	<RS232>	TRUE FALSE	1-1	R/W	Cell pressure
<IVOLT>	<RS232>	TRUE FALSE	1-1	R/W	Input voltage
<RAW>	<RS232>	TRUE FALSE	1-1	R/W	Raw detector readings
<ECHO>	<RS232>	TRUE FALSE	1-1	R/W	Echo commands sent to LI-820
<STRIP>	<RS232>	TRUE FALSE	1-1	R/W	Strip XML from all data sent

Example:

```
<LI820><CFG><OUTRATE>0.5</OUTRATE></CFG><RS232><STRIP>FALSE</STRIP><ECHO>FALSE</ECHO><CELLTEMP>TRUE</CELLTEMP><CO2ABS>TRUE</CO2ABS><CO2>TRUE</CO2><CELLPRES>TRUE</CELLPRES><IVOLT>TRUE</IVOLT><RAW>TRUE</RAW></RS232></LI820>
```

Appendix D

Tag	Parent	Value(s)	Cardinality	R/W	Comments
<CFG>	<LI820>	<OUTRATE> <HEATER> <PCOMP> <FILTER> <ALARMS> <DACS> <BENCH> ?	1-N		Elements within the <CFG> tag control system settings.
Example: <LI820><CFG><HEATER>TRUE</HEATER><PCOMP>TRUE</PCOMP></CFG></LI820>					

Tag	Parent	Value(s)	Cardinality	R/W	Comments
<OUTRATE>	<CFG>	0 to 20	1-1	R/W	Output data every N seconds (0.5 s increments).
<HEATER>	<CFG>	TRUE FALSE	1-1	R/W	Turn heater on/off.
<PCOMP>	<CFG>	TRUE FALSE	1-1	R/W	Pressure compensation on/off.
<FILTER>	<CFG>	0 to 20	1-1	R/W	Set a 0 to 20 second filter.
<ALARMS>	<CFG>	<ENABLED> <HIGH> <HDEAD> <LOW> <LDEAD>	1-N		High and low alarm settings.
<DACS>	<CFG>	<RANGE> <D1> <D2>	1-N		DAC outputs.
<BENCH>	<CFG>	5.5 14	1-1	R	Optical bench length.
	<CFG>	TRUE FALSE	1-1	R/W	Span range setting.

Appendix D

Tag	Parent	Value(s)	Cardinality	R/W	Comments
<ENABLED>	<ALARMS>	TRUE FALSE	1-1	R/W	Enable alarms.
<HIGH>	<ALARMS>	Integer	1-1	R/W	High alarm on at this value.
<HDEAD>	<ALARMS>	Integer	1-1	R/W	High alarm off at this value.
<LOW>	<ALARMS>	Integer	1-1	R/W	Low alarm on at this value.
<LDEAD>	<ALARMS>	Integer	1-1	R/W	Low alarm off at this value.
Example: <LI820<LI820><CFG><ALARMS><ENABLED>TRUE</ENABLED><HIGH>1600</HIGH> <HDEAD>1500</HDEAD><LOW>200</LOW><LDEAD>300</LDEAD></ALARMS></CFG> </LI820>					

Tag	Parent	Value(s)	Cardinality	R/W	Comments
<RANGE>	<DACS>	2.5 5.0	1-1	R/W	Output voltage. 2.5V or 5.0V.
<D1>	<DACS>	CO2 CELLPRES CELLTEMP	1-1	R/W	DAC1
<D2>	<DACS>	CO2 CELLPRES CELLTEMP	1-1	R/W	DAC2.
Example: <LI820><CFG><DACS><RANGE>2.5</RANGE><D1>CO2</D1><D2>CELLTEMP</D2></DACS></CFG></LI820>					

Tag	Parent	Value(s)	Cardinality	R/W	Comments
<CAL>	<LI820>	<DATE> <CO2ZERO> <CO2SPAN> <CO2LASTZERO> <CO2LASTSPAN> <CO2KZERO> <CO2KSPAN>	1-N		Calibrating parameters. When calibrating, <DATE> must be paired with a <CO2ZERO> or a <CO2SPAN>.

Appendix D

Tag	Parent	Value(s)	Cardinality	R/W	Comments
<DATE>	<CAL>	20 character date	1-1	W	The date the calibration is taking place.
<CO2ZERO>	<CAL>	TRUE FALSE	1-1	W	Start a CO ₂ zero.
<CO2SPAN>	<CAL>	Integer (CO2 ppm)	1-1	W	Start a CO ₂ span.
<CO2LASTZERO>	<CAL>	20 character date	1-1	R	The date the LI-820 was last zeroed.
<CO2LASTSPAN>	<CAL>	20 character date	1-N	R	The date the LI-820 was last spanned.
<CO2KZERO>	<CAL>	Float	1-N	R/W	Calibration constant.
<CO2KSPAN>	<CAL>	Float	1-1	R/W	Calibration constant.

Examples:

To Zero:
 <LI820><CAL><DATE>2001-02-07</DATE><CO2ZERO>TRUE</CO2ZERO></CAL></LI820>

To Span:
 <LI820><CAL><DATE>2001-02-07</DATE><CO2SPAN>1000</CO2SPAN></CAL></LI820>

Possible LI-820 Replies

<LI820><ACK>TRUE</ACK></LI820>
 <LI820><ERROR>{ ErrorText }</ERROR></LI820>
 <LI820><CAL><CO2LASTSPAN>
 { isodate }</CO2LASTSPAN><CO2LASTZERO>{ isodate }</CO2LASTZERO><CO2KZERO>{ float }
 </CO2KZERO> <CO2KSPAN>{ float }</CO2KSPAN> </CAL></LI820>

Tag	Parent	Value(s)	Cardinality	R/W	Comments
<ACK>	<LI820>	TRUE FALSE	1-1	R	Acknowledgement to a send command.
<VER>	<LI820>	Text	1-1	R	Embedded software version.
<ERROR>	<LI820>	Text	1-1	R	Error. Includes a message.

Warranty

Each LI-COR, inc. instrument is warranted by LI-COR, inc. to be free from defects in material and workmanship; however, LI-COR, inc.'s sole obligation under this warranty shall be to repair or replace any part of the instrument which LI-COR, inc.'s examination discloses to have been defective in material or workmanship without charge and only under the following conditions, which are:

1. The defects are called to the attention of LI-COR, inc. in Lincoln, Nebraska, in writing within one year after the shipping date of the instrument.
2. The instrument has not been maintained, repaired, or altered by anyone who was not approved by LI-COR, inc.
3. The instrument was used in the normal, proper, and ordinary manner and has not been abused, altered, misused, neglected, involved in and accident or damaged by act of God or other casualty.
4. The purchaser, whether it is a DISTRIBUTOR or direct customer of LI-COR or a DISTRIBUTOR'S customer, packs and ships or delivers the instrument to LI-COR, inc. at LI-COR inc.'s factory in Lincoln, Nebraska, U.S.A. within 30 days after LI-COR, inc. has received written notice of the defect. Unless other arrangements have been made in writing, transportation to LI-COR, inc. (by air unless otherwise authorized by LI-COR, inc.) is at customer expense.
5. No-charge repair parts may be sent at LI-COR, inc.'s sole discretion to the purchaser for installation by purchaser.
6. LI-COR, inc.'s liability is limited to repair or replace any part of the instrument without charge if LI-COR, inc.'s examination disclosed that part to have been defective in material or workmanship.

There are no warranties, express or implied, including but not limited to any implied warranty of merchantability of fitness for a particular purpose on underwater cables or on expendables such as batteries, lamps, thermocouples and calibrations.

Other than the obligation of LI-COR, inc. expressly set forth herein, LI-COR, inc. disclaims all warranties of merchantability or fitness for a particular purpose. The foregoing constitutes LI-COR, inc.'s sole obligation and liability with respect to damages resulting from the use or performance of the instrument and in no event shall LI-COR, inc. or its representatives be liable for damages beyond the price paid for the instrument, or for direct, incidental or consequential damages.

The laws of some locations may not allow the exclusion or limitation on implied warranties or on incidental or consequential damages, so the limitations herein may not apply directly. This warranty gives you specific legal rights, and you may already have other rights which vary from state to state. All warranties that apply, whether included by this contract or by law, are limited to the time period of this warranty which is a twelve-month period commencing from the date the instrument is shipped to a user who is a customer or eighteen months from the date of shipment to LI-COR, inc.'s authorized distributor, whichever is earlier.

This warranty supersedes all warranties for products purchased prior to June 1, 1984, unless this warranty is later superseded.

DISTRIBUTOR or the DISTRIBUTOR'S customers may ship the instruments directly to LI-COR if they are unable to repair the instrument themselves even though the DISTRIBUTOR has been approved for making such repairs and has agreed with the customer to make such repairs as covered by this limited warranty.

Further information concerning this warranty may be obtained by writing or telephoning Warranty manager at LI-COR, inc.

IMPORTANT: Please return the User Registration Card enclosed with your shipment so that we have an accurate record of your address. Thank you.

LI-COR[®]

Biosciences

LI-COR, inc. ● Environmental ● 4421 Superior Street ● P.O. Box 4425 ● Lincoln, Nebraska 68504 USA

Phone: 402-467-3576 ● FAX: 402-467-2819

Toll-free 1-800-447-3576 (U.S. & Canada)

E-mail: envsales@licor.com

Internet: <http://www.licor.com>